

# XCMG Truck Crane

XCT80\_Y



# Main Components - XCT80\_Y

XCMG truck crane XCT80\_Y has the maximum lifting capacity of 80 t. Its longest boom length is 45.5 m and the maximum lifting height is 60.9 m (including the jib).

## Chassis

### Frame

It is designed and manufactured by XCMG. It is made of high strength steel with fully covered walking surface and anti-torsion box-typed structure.

### Outriggers

Four outrigger are arranged with 5th jack made available. It is arranged in H-shape and are hydraulically controlled by control levers. Double-stage outrigger beam is adopted. There is an outrigger control station located at each side of the chassis and there is a level gauge on each control station.

The outrigger movements can be simultaneously or separately controlled from any side of the chassis. There is a check valve fitted in each outrigger cylinder and a double-way hydraulic valve fitted in each jack cylinder. Outrigger float diameter is  $\phi 450$  mm. Reaction force of outrigger at max. lifting load is 700kN.

### Engine

Dongfeng Cummins, In line, water cooled, four-stroke, supercharging, high pressure common rail QSL8.9-C360-30 with rated power of 265 kW / 2100 rpm and max. torque is 1500 Nm / 1400 - 1600 rpm. Compliant to China III emission standard. Fuel tank capacity is 300L.

### Transmission

Mechanical transmission 10JSD140TB with manual flexible shaft control, 10-forward speed and 2-reverse speed with a synchronizer.

### Axles

High strength axle makes the machine reliable.

### Suspensions

Rubber spring suspensions with V-type push rods are adopted for rear suspension system leading to improved chassis stability and reduced tyre wear.

### Tyres

12.00R24, low noise during traveling and strong bearing capacity .

## Brakes

**Service braking:** Foot pedal is operated using double-circuit air pressure brake. 1st circuit acts on the wheels of 1st and 2nd axles, and 2nd circuit acts on the wheels of 3rd and 4th axles.

**Parking brake:** Spring-loaded brake acts on wheels of axles 2,3 and 4.

**Auxiliary brake:** Engine compression and exhaust brake, is safe and reliable and prolongs the brake lining service life.

## Steering

Mechanical steering mechanism is with a hydraulic booster.

## Electrical system

24V DC, two sets of 12 V battery in series. Generator:  $28 \pm 0.3$  V-70 A

## Safety devices

Hydraulic balance valve, hydraulic relief valve, LMI, spring centering system for control levers, lowering limiter for preventing wire rope from over releasing, anti-two block at boom head for preventing wire rope from overwinding, free sliding and slewing locking are standard.

Double-way hydraulic valve are available while winch monitoring device, tri - coloured light bar, beacon lamp, beacon lamp for slewing, angle indicator, yellow reflecting marking, backup camera and ABS are optional.

## Superstructure

### Hydraulic system

Variable pump driven by chassis engine is used for hoisting, elevating and telescoping operations. It has a load sensing proportional multi-way change valve with impact resistance valve, cavitation - proof valve integrated and air-cooled hydraulic oil radiator. Tank capacity is 972L.

### Operator's cab

Luxurious new steel cab with safety glass and sun shield are used for windows, electrically operated door window lifters, adjustable seats, electrically adjustable mirrors, steering wheel adjustable in height and angle, liquid crystal display and radio cassette player are equipped. Heater and air conditioner are standard.

# Main Components - XCT80\_Y

A swing-out door is equipped. The cab features a new ergonomic seat design with back rest adjustment. Wipers are fitted for the windshield and roof window. Standard controls and indicators are ergonomically arranged in the cab. Extension of control lever is in mechanical control system.

## Operating mode

Pilot hydraulic control is used for controlling the superstructure. All crane movements are controlled by hydraulic pump and proportional valve are through two control levers at left and right sides.

## Main and auxiliary winch system

Hydraulic control is used for speed regulation. The system is driven by a hydraulic motor through a planetary gear reducer with a normally closed brake, a balance valve and a grooved drum is equipped.

## Slewing system

Four-point contact-ball slewing ring is driven by the planetary gear reducer of slewing mechanism which is driven by a hydraulic motor and can continuously slew at 360°. Power control and free slewing function as well as step-less speed regulation are available. There is also a horn switch fitted on the slewing control lever.

## Elevating system

A front support double-acting hydraulic cylinder is equipped for elevating operation with a balance valve fitted.

## Combined counterweight

Total weight is 5.3t. Two counterweight configurations of 5.3t and 2.2t are available.

## Hook block

80t hook block and 4.5t hook block are available while 35t hook block is an optional.

## Boom and jib system

### Boom

Comprises of welded one basic boom and four telescoping boom sections with U-shaped cross-section and adopts anti-distortion design. It is made of high strength structural steel, single-cylinder plus ropes telescoping system. Boom length is 11.83m - 45.5m.

### Swing-away jib

Welded, two-section lattice jib. It has three offset

angles of 0°, 15° and 30°. Fixed jib length is 9.5m - 16m.

### Under lung jib

Two-section box-type jib is stowed under boom. One jib section is 9.8 m and the total length of two jib sections is 16 m. The jib has offset angles of 5°, 15° and 30°.

### Single top

It is installed at the boom top for single line operation. Its lifting performance is the same as that for the boom but the maximum lifting load cannot exceed 4.5t.

## Operational Safety Instructions

1. The total rated loads given in the rated load charts are the maximum lifting capacities when the crane is set up on firm and level ground, which includes the weight of the hook block and slings. The weight of above-mentioned devices should be deducted to correctly calculate the load weight.
2. The working radius shown in the rated load charts is the radius when the load is lifted off the ground and it is the actual value including loaded boom deflection.
3. A lifting operation is permissible only when the wind force is below grade 5 (instantaneous wind speed is 14.1 m/s, wind pressure is 125N/m<sup>2</sup>).
4. Before beginning the lifting operation, the operator should know the weight of the load to be lifted and its working range. Then select proper working conditions. Never operate the crane beyond the limit shown in the chart. Use the lower value from the chart when the boom length or working radius is between the range of values.
5. Observe the boom angle limit. Never operate the crane with the boom angle beyond the recommended limit even if the load is not being carried. Otherwise, the crane will tip.
6. The boom length given in the rated load charts should accord with the telescoping code of boom sections.

# Dimensions - XCT80\_Y

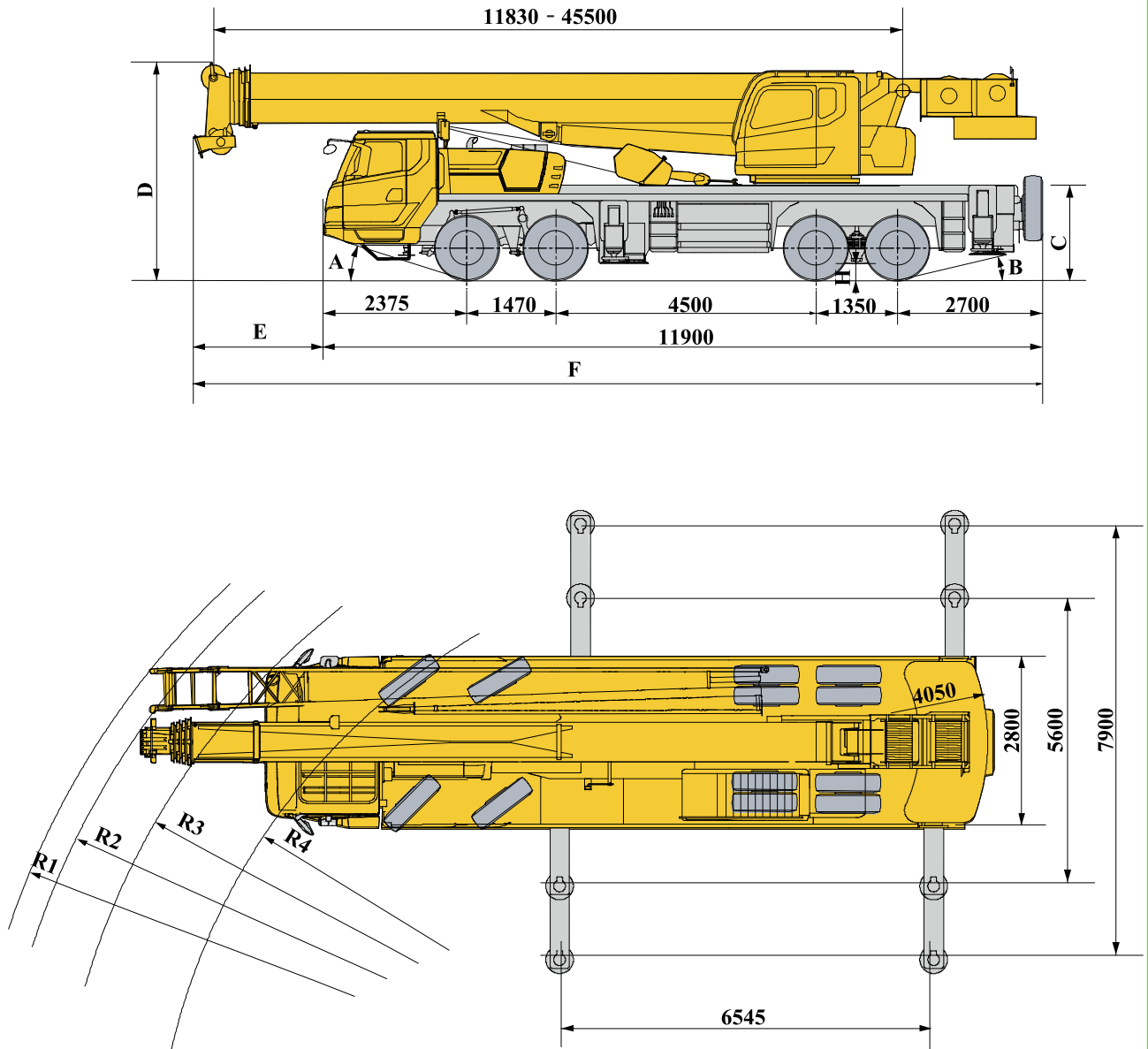

The medium and large tonnage products increase the full-scale shape and size parameter map, and the corresponding weight tail radius of gyration A: Approach angle B: Departure angle C: plane height on the frame D: vehicle height E: vehicle width R1: minimum turning radius of the arm head (the main arm and the jib are determined according to the size) R2: Minimum turning radius of the body R3: minimum turning radius H: minimum ground clearance.

	A	B	C	D	E	F	R1	R2	R3	R4	H
12.00R24	22°	13°	1725	3770	1690	14085	14500	14100	13500	12000	305

# Technical Specifications

## Travel Configuration





















Category	Item	Unit	Parameter		
Dimensions	Dimensions (length×width×height)	mm	14085×2800×3770		
	Wheel base	mm	1470+4500+1350		
	Track (Front / rear)	mm	2316 / 2063		
	Front / rear overhang	mm	2375 / 2700		
	Front / rear extension	mm	1690 / 0		
Weight	Total vehicle mass in travel configuration	Kg	46000		
	Axle load	1st axle and 2nd axle	Kg	10000	
		3rd axle and 4th axle	Kg	13000	
Power	Engine model	—	QSL8.9 - C360	WD615.334	
	Rated power / rpm	kW / (r/min)	265 / 2100	247 / 2200	
	Max. net power / rpm	kW / (r/min)	250 / 2100	245 / 2200	
	Max. output torque / rpm	m / (r/min)	1500 / 1400 - 1600	1350 / 1100 - 1600	
Travel	Max. travel speed	km / h	50 / 90		
	Min. stable travel speed	km / h	2 - 3		
	Min. turning diameter	m	≤24		
	Min. turning diameter at boom tip	m	≤30.2 (Swing - away jib)		
			≤30.24 (Under lung jib)		
	Min. ground clearance	mm	305		
	Approach angle	°	22		
	Departure angle	°	13		
	Braking distance (at 30 km / h)	m	≤10		
	Max. gradeability	%	≥40		
Fuel consumption per 100 km	L	38			
Noise	Exterior noise level	dB(A)	≤84 - ≤122		
	Noise level at seated position	dB(A)	≤90		

# Technical Specifications

Category	Item		Unit	Parameter	
Main performance	Max. total rated lifting capacity		t	80	
	Min. rated working radius		m	3	
	Turning radius at turntable tail	Counterweight	mm	4050	
		Winch	mm	4190	
	Max. load moment	Base boom	kN.m	2587	
		Fully - extended boom	kN.m	1286	
		Fully - extended boom + jib	kN.m	706	
	Outrigger span	Longitudinal	m	6.5	
		Lateral	m	7.9	
	Hoist height	Base boom	m	12.2	
		Fully - extended boom	m	46	
		Fully - extended boom + jib	m	60.9	
	Boom length	Base boom	m	11.83	
Fully - extended boom		m	45.5		
Fully - extended boom + jib		m	61.5		
Jib offset angle		°	0, 15, 30		
Working speed	Boom raising time		s	≤55	
	Boom fully extending time		s	≤110	
	Max. slewing speed		r / min	≥2	
	Outrigger extending and retracting time	Outrigger beam	Retracting	s	≤30
			Extending	s	≤30
		Outrigger jack	Retracting	s	≤30
			Extending	s	≤40
	Hoisting speed (single line, 4th layer, no load)	Main winch	m / min	≥145	
Auxillary winch		m / min	≥90		



# Description of Symbols - XCT80\_Y

General symbols					
	Superstructure		Jib offset angle		Tyres
	Lifting capacity		Hoist height with jib		Outriggers
	Boom length		360° operation of the boom with 5th jack down		Hook block
	Radius		Chassis		Counterweight
	Boom angle		Axle		Winch
	Hoist height with boom		Driving speed		360° operation of the boom
	Fixed jib length		Gradeability		







## Weight

	Axle	1	2	3	4	Total weight
	t	10	10	13	13	46

	Hook	No. of lines	Weight (kg)	Dimensions(mm)	Remarks
	80t	13	616	1325x544x537	Single hook, standard
	35t	10	403	1334x544x419	Single hook, optional
	4.5t	1	100 (Swing - away jib)	536x298x298	Single hook, standard

## Working speeds

			
	12.00R24	2 - 50	40%

	Drive	Working speed	Max. single line pull	Rope diameter/ length
	1	0-145 m / min, single line, 4th layer	6.5t	20mm / 230m
	2	0-90 m / min, single line, 4th layer	6.5t	20mm / 145m
	360°	0-2 r / min		
		Approx. 55s for boom elevation from - 1° to 81°		
		Approx. 110s for boom extension from 11.4m to 43.5m		

# Boom / Jib combinations - XCT80\_Y





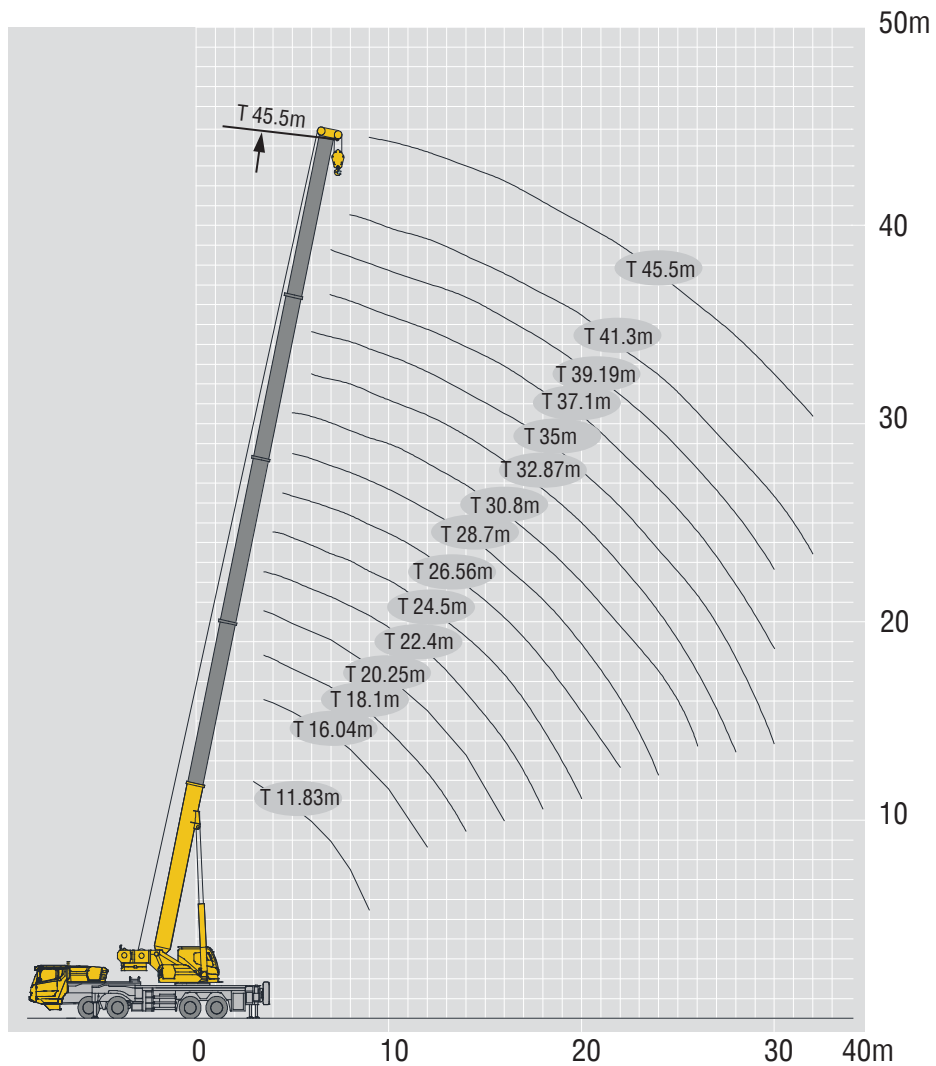

Telescopic boom	Jib
T : 11.83 - 45.5m	T : 45.5m J : 9.5m / 16m





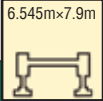

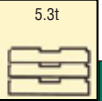
# Lifting Capacities - XCT80\_Y

										
m	28.7	30.8	32.87	35	37.1	39.19	41.3	45.5	m	
3									3	
3.5									3.5	
4									4	
5									5	
6	29.2	19.9	22.5						6	
7	28.3	18.5	21.4	18.4	14.0	15.5			7	
8	26.5	17.2	19.8	17.4	13.6	15.3	11.6	9.8	8	
9	24	16.2	18.4	16.4	12.9	14.5	11.6	9.6	9	
10	19.7	15.2	17.1	15.6	12.0	13.6	11.5	9.6	10	
12	14.2	13.5	13.8	14.0	10.8	12.2	10.7	9.6	12	
14	10.8	11.8	10.4	11.3	9.6	10.9	9.8	8.9	14	
16	8.5	9.4	8.1	8.9	8.5	8.5	8.6	8.2	16	
18	6.7	7.6	6.4	7.2	7.6	6.8	7.5	7	18	
20	5.4	6.3	5	5.8	6.5	5.5	6.1	5.8	20	
22	4.4	5.2	4	4.8	5.5	4.4	5.1	4.7	22	
24	3.6	4.4	3.2	4	4.6	3.6	4.2	3.9	24	
26		3.7	2.5	3.3	3.9	2.9	3.5	3.2	26	
28			1.9	2.7	3.3	2.3	3	2.6	28	
30				2.2	2.8	1.9	2.5	2.1	30	
32					2.4	1.5	2	1.7	32	
34							1.7	1.4	34	

# Lifting Heights - XCT80\_Y

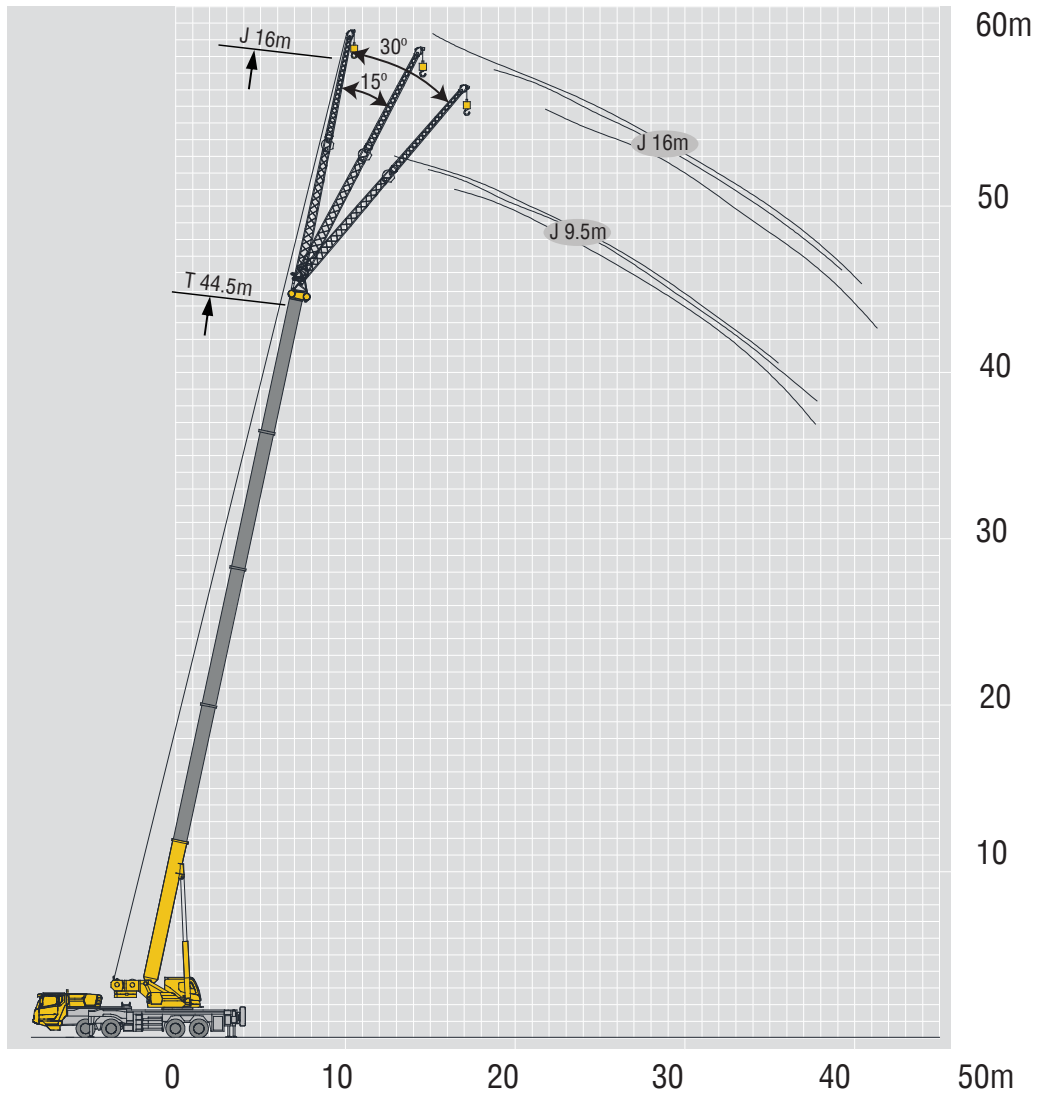





# Lifting Capacities - XCT80\_Y

	9.2m			16m			
	0°	15°	30°	0°	15°	30°	
80°	4.5	4	3.2	2.9	2.4	1.3	80°
78°	4.2	3.8	3.2	2.9	2	1.1	78°
75°	4	3.7	3	2.8	1.6	1	75°
72°	3.8	3.5	2.7	2.5	1.4	0.9	72°
70°	3.6	3.2	2.6	2.2	1.2	0.9	70°
65°	2.6	2.4	2.2	1.6	1	0.9	65°
60°	1.7	1.6	1.5	1.2	0.9	0.8	60°
55°	1.2	1.1	1	0.9	0.8	0.7	55°
50°	0.7	0.7	0.7				50°

# SCHWING - STETTER ALWAYS CLOSE TO THE CUSTOMER.



-  Sales Office
-  Resident Engineer
-  Resident Engineer with Spares Depot
-  Service Centre with Spares Depot
-  Dealership Support
-  Customer Training Center

## SCHWING STETTER (INDIA) PVT LTD

An ISO 9001 : 2015 Company

**CORPORATE OFFICE** : F 71 - 72, SIPCOT Industrial Park, Irungattukottai, Sriperumbudur Taluk, Kancheepuram District, Tamil Nadu - 602117.  
Tel : 044 - 71378100 / 106  
Email : chennai@schwingstetterindia.com

**Mumbai** : 620/621, Nirmal Lifestyle Corporate Centre, 6<sup>th</sup> floor, LBS Marg, Mulund (West), Mumbai - 400080.  
Tel : 022 25624863 / 64, 30718300, 71378100  
Fax : 022 25624865 / 66  
Email : mumbai@schwingstetterindia.com

**New Delhi** : 19, Okhla Industrial Estate, Phase III, New Delhi - 110 020.  
Tel : 011 33555588  
Email : newdelhi@schwingstetterindia.com

**Kolkata** : 4<sup>th</sup> Floor, Mira Towers, Plot No. 27, Block EP, Sector V, Electronics Complex, Salt Lake City, Kolkata - 700091. Tel: 033 40823300  
Email : kolkata@schwingstetterindia.com

**Hyderabad** : No.8-2-268/1/C, Plot 2, Road 3, Arora Colony, Banjara Hills, Hyderabad-500034.  
Tel: 040 33555588 / 47848601 Fax: 040 23731770  
Email : hyderabad@schwingstetterindia.com

**Mohali** : D 91-PH-VII, Industrial Area, Mohali, Punjab - 160 055. Tel : 0172 3957500 / 3957501  
Email : chandigarh@schwingstetterindia.com

**Bengaluru** : No 138-B, "UDAYAGIRI COMPLEX", 3rd Phase, KIADB Industrial Area, Peenya, Bangalore - 560058. Tel: 080-68114300  
Email : bangalore@schwingstetterindia.com

**Visakhapatnam** : Plot No.54, IDA - Block 'D', Expansion, Auto nagar, Visakhapatnam - 530 012.  
Tel : 09100061783 Fax: 0891 2706063

**Jammu** : C/o. VRL Logistics Limited, Plot No. 19, Transport Nagar, Narwal, Jammu - 180006.  
Tel : 099060 35941.

**Ahmedabad** : 103, Shivalik Arcade, 100 Ft., T.P Anand Nagar, Satellite Road, Ahmedabad - 380 051.  
Tel : 079 71378100  
Email : ahmedabad@schwingstetterindia.com

**Cochin** : No.134 / 1404 B, Arakkakadavu Road, Anchumana, Edappally P.O. Cochin - 682 024.  
Tel: 0484 - 3355558 / 4055544 Fax: 0484 4506165  
Email : cochin@schwingstetterindia.com

**Bhubaneswar** : Plot No:182, Naharkanta, Rudrapur Beside Puri Main Canal, NH5, Bhubaneswar-752101. Odisha. Tel : 09078884484 / 85

**Pune** : Baner Biz Bay, A Wing, 7<sup>th</sup> Floor, Office No. A-701 & 702, Baner Road, Near D-Mart, Pune - 411 045. Tel: 020-6718500  
Email : pune@schwingstetterindia.com

**Coimbatore** : 2005, Trichy Road, Old Rajalaxmi Mills, Singanallur, Coimbatore-641005. Tel: 0422 3223660  
Email : coimbatore@schwingstetterindia.com

**Raipur** : NH-6, Opposite Vardhaman Motor, Kumahari, Dist - Durg, Chhattisgarh - 490042.  
Tel : 07821 247066  
Email : sunil.kumar@schwingstetterindia.com

**Patna** : C/o. House of Ashok Kumar Rana, Ground & First Floor, Samridhi Bhawan, Agamkuan Road, Shivaji Colony, Pahari More, Patna - 800007, Bihar. Tel : 09570996702  
Email : rajiv.chandra@schwingstetterindia.com

**Surat** : Shop No. 128, First Floor, Aagam Orchid, TP Scheme No 6, Opp. Shiv Kartik Complex, Off VIP Road, Nr. Shrunagar Building, Nr Nandini 2, Vesu, Surat-395007 Tel : 08980002726  
Email : ahmedabad@schwingstetterindia.com

**Guwahati** : House No. 161, Jaya Nagar, Six Miles, Khanapara, Guwahati - 781 022.  
Tel: 0361 2234738 / 099575 66738

**Goa** : C/o Agarwal Packers and Movers Limited, Plot No X-1, Verna Industrial Estate, Verna, Goa - 403722. Tel: 09820203847  
Email : sohit.chakhaiyar@schwingstetterindia.com

**Nagpur** : C/o Amrut Dairy Farm, No. 118, Opp VCA Stadium, Jamtha, 16th KM Milestone, NH-7, Wardha Road, Nagpur - 441108. Tel : 09820203847  
Email : sohit.chakhaiyar@schwingstetterindia.com

**Indore** : Plot No.1074/9/1, A.B. Road (By-Pass), (Opp) Silicon Valley Housing Project, Rau - 453331, Indore. M.P. Tel : 08085966587  
Email : ahmedabad@schwingstetterindia.com

**Jaipur** : F-551, Road No. 6, Lehar Choraha, Vishwakarma Industrial Area (VKI Area), Jaipur - 302 013, Rajasthan. Phone: 09672423444